



WWW.SIM2USA.COM

SIM2 USA INC.
10108 USA Today Way
Miramar, FL 33025
Tel. +1.954.442.2999
Telefax +1.954.442.2998
E-mail: sales@sim2usa.com
Web site: www.sim2usa.com

Headquarters:
SIM2 MULTIMEDIA S.p.A.
Viale Lino Zanussi, 11
33170 Pordenone - Italy
Tel. +39.0434.383 256
Telefax +39.0434.383 260
E-mail: info@sim2.it
Web site: www.sim2.com

Germany:
SIM2 DEUTSCHLAND GmbH
Industriepark, 17
D - 56291 Wiebelsheim
FreeCall 0800-800 7462
Tel. +49.0700.400 500 66
Telefax +49.0700.700 800 99
E-mail: info.de@sim2.it

UK:
SIM2 UK LTD
Steinway House
Worth Farm, Little Horsted
Nr. Uckfield
East Sussex TN22 5TT
Tel. +44.01825.750 850
Telefax +44.01825.750 851
E-mail: info@sim2.co.uk
Web site: www.sim2.co.uk

SIM2 Multimedia is certified



SIM2 *Grand Cinema Line*



Due to constant product development, specifications and design might be subject to change without notice. GC Catalog USA - July 2005



Contents

About SIM2 Multimedia

2



About DLP technology

6



Introduction to the
Grand Cinema series

8



The Grand Cinema HT series
DLP™-based front projectors

11



The Grand Cinema RTX series
DLP™-based rear projectors

26



The Grand Cinema HTL series
LCD displays

36

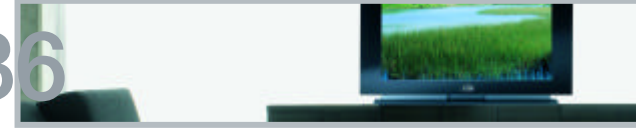

The Technical Specifications

39



SIM2 Multimedia

Innovation in home cinema



SIM2 Multimedia mission is to offer solutions for home cinema applications: in other words, truly sensational rear (45" and 55" diagonal) and front projection products, capable of outputting a picture up to 150-300" diagonal.

SIM2 products are designed for today's and future requirements and incorporate all of those exceptional performances that have created the SIM2 legend.

In the home theater market, SIM2 Multimedia is today's synonymous of innovation and quality. The company provides one of the industry's most comprehensive line of video entertainment projectors and high-end professional display that have a common denominator: a cinematographic quality for future-proof products.

The marketing policies of the company are world-oriented with a direct presence through the headquarter/subsidiary in Italy, USA, UK and Germany and in over 45 countries world-wide through partnerships with qualified distributors.

SIM2 Multimedia's headquarters are located in Pordenone, Italy. The capillary, world-wide distribution, coupled with an excellent customer service, guarantees absolute serenity in time.



SIM2 celebrates 10 year anniversary

In 2005, SIM2 Multimedia celebrates its first 10 years of operation.

Since its founding in July 1995, SIM2 has grown from a small company to one of the most hotly sought-after manufacturer of top-notch products, continuously meeting the needs of the home entertainment market with products embodying the very best in performance and available technology. Today we have a permanent staff of 125 and have earned a reputation for our continuous innovation and the quality of our products.

SIM2 Research & Development

SIM2 has gained in reputation thanks to its strong commitment on innovation and great passion for outstanding image quality. Indeed, SIM2 Multimedia invests over 20% of its human resources and over 10% of total turnover in R&D activities, assuring constant innovation of products.

SIM2 Research & Development team's achievements:

1. an innovative "alpha path" light engine for a revolutionary product series.
2. the best signal processing device coupled with the most sophisticated deinterlacer;
3. a wide selection of connections to allow interface with today's and future sources; in particular, the latest HDMI™ (High Definition Multimedia Interface) input that safely processes uncompressed signals, making illegal reproductions impossible to accomplish; HDMI™ doesn't require any analog/digital conversion - and/or vice versa - and controls simultaneously up to 8 audio channels with a quality higher than the one offered by normal CDs.
4. the use of fiber optics cable. SIM2 is the only consumer manufacturer to use an optical link between a remote and external video processing unit (DigiOptic™ Image Processor) and the projector for a loss-free and interference-free signal.



home is where the theater is



It has often been said, "A man's home is his castle". With that adage in mind, it's no surprise that more and more people are choosing to enjoy their favorite movies, sporting events and TV programs in the comfort of their own private theater. Whether you're an avid host or prefer quiet evenings at home, a personal theater allows you to express your style in entertainment.

A name you can trust

On the basis of more than 10 years of experience in cutting edge innovation, SIM2 Multimedia, is a world-leading manufacturer dedicated to bringing a cinema-quality picture into your home. Investing in a SIM2's projector you can be confident that it will deliver on sharpness, brightness and color fidelity.

Sit back, relax and enjoy

A home theater creates an exclusive domain within your living space, where the reality of your surroundings is suspended and you're immersed in a total entertainment experience. Imagine enjoying a great football game or movie in the intimate surroundings of friends and family with cinema-quality projection and sound. A SIM2 projector is an essential part of this experience.

If you're like most people, you want to make the most of your leisure time

SIM2 Multimedia design engineers pay particular attention to ensure that their projectors are an attractive addition to your home. Your family and friends will immediately notice the elegant design, which is certain to complement your décor. Furthermore, all SIM2's projectors offer relaxed ease-of-use via remote control and our comprehensive warranties ensure peace of mind.



Your attitude toward entertainment is as unique as your personality

Regardless of the size of your home, you may have concerns about how a personal theater will transform your living space. Retractable screens and ceiling or bookshelf mounted projectors allow you to convert a multi-purpose living area into a theater at your discretion. You may also choose to design a dedicated home theater room with a wall-mounted screen. Whatever the case, creating a theater that complements the personality of your home should be a fulfilling experience; the possibilities are as endless as your imagination.

DLP™ technology



Digital Light Processing (DLP™) is a new way to project and display video signals and is based on the Digital Micromirror Device (DMD) developed by Texas Instruments.

The inherent digital nature of DLP™ enables noise-free, precise image quality with digital grey scale and very good color reproduction.

Finally, close spacing of the micromirrors causes video images to be projected as seamless pictures with higher perceived resolution.

How it works

A DMD can be described simply as a semiconductor light switch. Thousands of tiny, square, 13x13 μm mirrors, fabricated on hinges atop a static random access memory (SRAM) make up a DMD.

Each mirror is capable of switching a pixel of light. The hinges allow the mirrors to tilt between two states: "on" or "off".

Dark-metal technology

In first-generation DMD systems, the particles of light occasionally escaped to screen, subtly affecting the contrast ratio of the projected image. In the DarkChip™ generation, a light-eating "dark metal" coat is applied to the interior of each chip, preventing stray light from traveling to screen when mirrors are switched off. Now, photons go only where they're wanted.



One-chip system

White light passes through a color wheel filter, causing red, green and blue light to be shone in sequence on the surface of the DMD. The color wheel spins at 60 Hz to give 180 color fields per second (256 shades for each of the primary colors, or 2563 - 16.7 million - possible colors that can be generated).

The switching of the mirrors, and the proportion of time they are 'on' or 'off' is coordinated according to the color shining on them. The human visual system integrates the sequential color and sees a full-color image. A white segment may be added to increase brightness efficiency of the system.

Three-chip system

DLP™ technology-enabled projectors for very high image quality or high brightness applications such as cinema and large venue displays rely on a 3-DMD-chip configuration to produce stunning images, whether moving or still.

In a 3-chip system, the white light generated by the lamp passes through a prism that divides it into red, green and blue. Each DMD chip is dedicated to one of these three colors; the colored light that the micromirrors reflect is then combined and passed through the projection lens to form an image.

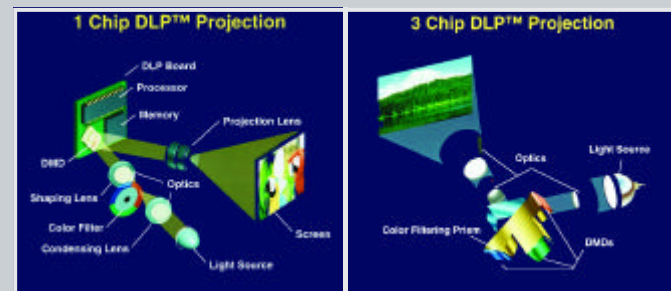

Advantages in Home Entertainment

Sharper image: all digital technology recreated the source with maximum fidelity so you may enjoy clear, sharp pictures.

Knockout color: high contrast and better accuracy mean brilliant colors and richer blacks.

Slim design: lightweight semiconductor technology allows for thin and elegant TVs and projectors.

GRAND CINEMA series

the ultimate home theater experience



Grand Cinema Line - Cutting-edge technology combined with elegance and style; brought to you by the masters in home cinema projection: SIM2!

The SIM2 Grand Cinema Line has been created to endorse the strategic positioning of SIM2 within the home theater marketplace and to fulfil the needs of a discerning customer seeking to enjoy a truly high end "ultimate home cinema experience", whilst being backed up with reliable product support from qualified staff.

All Grand Cinema products have been designed and manufactured using the most advanced cutting edge technology available to the current marketplace; the SIM2 Research and Development team working closely with new technologies to develop the ultimate image quality.

key points

- ✦ Designed specifically for home theater
- ✦ Based on Texas Instruments' DLP™ technology
- ✦ Built-in deinterlacer and video processor
- ✦ Lens shift and digital keystone adjustment
- ✦ Long Throw Ratio zoom lens
- ✦ HDMI™ and DVI inputs
- ✦ Improved software functions



We have changed the rules of the game

Grand Cinema offers a hands on approach to cinema viewing. An extremely sophisticated and versatile firmware and software, gives the customer the enjoyment of self customizing a fully adjustable user interface, allowing the viewer to tailor the picture to their exacting requirements.

Alternatively, this fully customizable interface offers flexibility to professional installers and lifestylers, allowing them to set-up the projector to deliver the best image quality for the living conditions.

The recent introduction of new projectors to the Grand Cinema range, together with the introduction of HDMI™

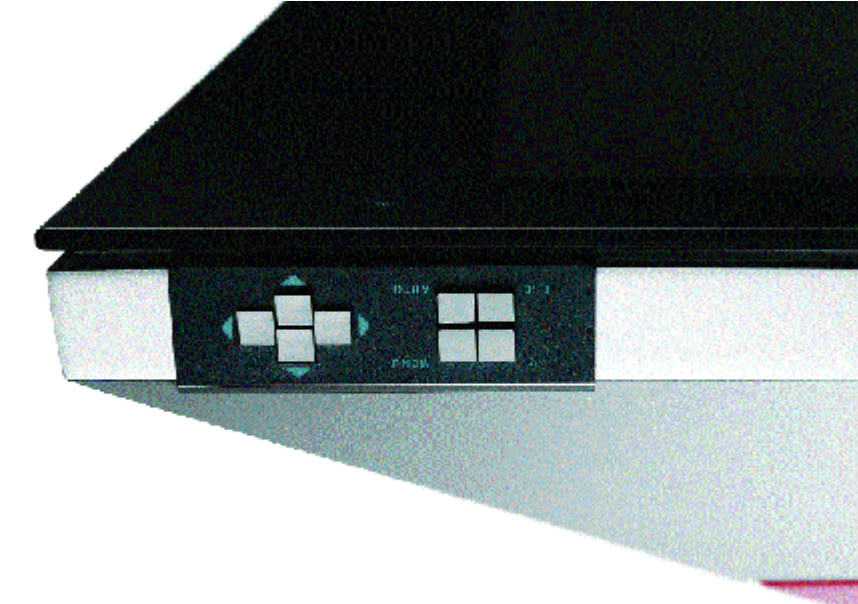

digital Input, places SIM2 firmly at the forefront of the technology revolution.

The SIM2 Grand Cinema range is the only projector line that features HDMI™ Input across the entire range. SIM2 is the only company in the home theater industry Worldwide to currently offer this to the customer.

The Grand Cinema line has received a plethora of prestigious international awards for excellence in its category, aesthetics, innovation, etc.



SIM2's proprietary engine and optical path

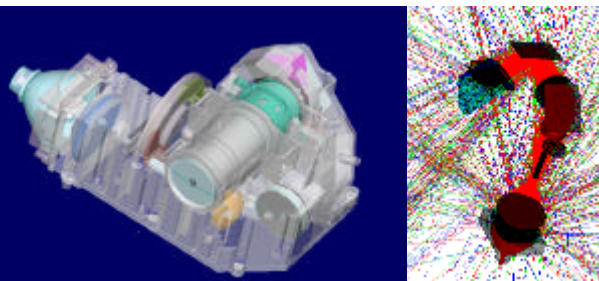

Since the introduction of the Grand Cinema line to the World market in 2000, the SIM2 Research & Development team have been praised and acknowledged for their outstanding achievements, no exception being the revolutionary "alpha path" light engine.

SIM2's optical engineers have once again achieved an extraordinary goal after months of research and development activities, resulting in a new optical engine, which has an absolutely perfect light path, delivering outstanding colors and reaching very high and true contrast ratios.

The coupling of this revolutionary new light engine with the newly introduced HDMI™ Input has brought about a truly exceptional picture quality that has never before been experience!

Last, new electronics and software functions are now featuring the Grand Cinema Line such as a new Formatter Board that is integrated with the latest Video Processor. This hardware and software new implementation, together with others, allow functions such as Video Noise Reduction, Flesh Tone Correction, Customized Adjustment of all parameters, Overscan of 33 different positions, Auto POWER ON selectable and many others.



Grand Cinema HT

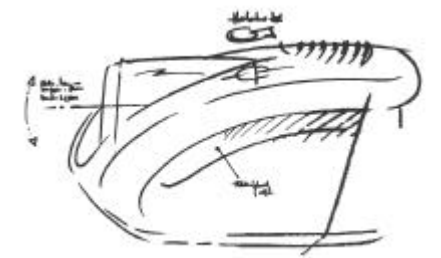

In the year 2000, SIM2 has revolutionized the home theater market with the introduction of the SIM2 GRAND CINEMA HT series: the new projector line based on Digital Micromirror Device by Texas Instruments.

The SIM2 GRAND CINEMA HT series has been completely designed by SIM2 specifically for home theater and home entertainment applications with a specific criteria in mind: the best performance without compromise for a product that fulfils the requirements of the most demanding home theater enthusiast.





HT500 E-LINK and HT500 E

Optical Freedom

key points

- ✦ **3-chip HD2+ DarkChip™ DMDs** by Texas Instruments
- ✦ 720p High Definition native resolution (**1280x720 pixels**)
- ✦ Phenomenal **contrast ratio (>4300:1)** & brightness
- ✦ **SIM2 Live Colors Management (LCM) and Gamma functions**
- ✦ **Intelligent Memory functions**
- ✦ **HT500 E-LINK only:** External **DigiOptic™ Image processor** with 12 inputs
- ✦ **HT500 E-LINK only:** **Fiber optics connection** up to 500 m (1600 ft)
- ✦ Low noise operation and no rainbow effect
- ✦ **HDMI™-HDCP input**
- ✦ Choice of **5 high quality zoom lenses**
- ✦ Screen size up to 9 meters (>29 ft)
- ✦ On Board Video Processing

Featuring SIM2 LCM and Gamma control software and three HD2+ DMD chips by Texas Instruments, the HT500 E-VOLUTION projectors - namely HT500 E-LINK and HT500 E - deliver a resolution of 1280x720 for a flawless home theater excellence.

These projectors have been built to deliver a "real" home cinema experience, delivering a perfect image where other projectors fall fawl to the constraints of a screens dimensions and only before seen at commercial cinemas.

HD2+ DarkChip2™ by Texas Instruments

The HT500 E-LINK and HT500 E projectors are the first 3-chip on the market to feature the HD2+ DarkChip2™ by Texas Instruments (HD2+ DC2). The DarkChip2™ incorporates smaller mirror hinges, reduced gaps between mirrors, a flatter, more reflective surface and a light absorbent coating for unmatched contrast and color uniformity. Also, the DarkChip2™ coupled with improved software and SIM2 high quality optics allow

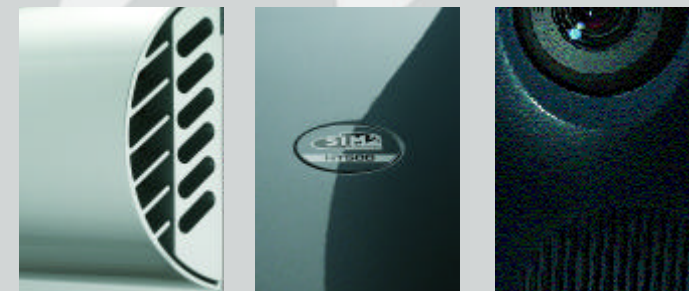

the HT500 E-LINK and HT500 E to reach a true contrast ratio of >4300:1 thus delivering on screen the crispest, sharpest and truest color image.

SIM2 Live Colors Management (LCM) and Gamma functions

SIM2's engineers have given the HT500 E-LINK an ultra-sophisticated software design that's worthy of the most discerning home theater enthusiast.

The LCM algorithm allow the precise adjustment of the color temperature to user preference, by choosing from the 36 predefined white points in CIE Chart.

And, the Gamma Tables provide a wide range of possibilities to optimize image based on variations in the source material, ambient lighting, and individual preferences: 1 Standard curve for movies, 5 SIM2 Enhanced curves to fully exploit the advantages of DLP™ technology, 2 Graphics curves for PC and graphic sources, and a User adjustment with 16 parametric gamma curves (ranging from 1.5 to 3 with a 0.1 increment).



HT500 E-LINK only: Positioning the DigiOptic™ Image Processor

The ideal location for the DigiOptic™ Image Processor is on a cabinet shelf or on a rack (dimensions compatible with a standard 19" rack). Make sure that the support surface is stable and that the unit has sufficient space around it for ventilation purposes (at least 3 cm).



HT500 E-LINK

Intelligent Memory functions

The HT500 E-LINK and HT500 E can store up to 3 image memory settings such as brightness, contrast, color temperature, etc. for each input; that is 75 and 24 settings respectively. When you select a new source, the parameters stored in each memory may be applied simultaneously. Or, you may simply choose to recall despite the change of source.

Future proof

The E-volution projectors feature an impressive array of digital connections, including DVI and HDMI™ inputs (on HT500 E, HDMI™ only). HDMI™ is a purely digital connection that transmits the uncompressed bitstream directly from the source through to the display and is backwards compatible with DVI.

On board Video Processing guarantees an image

that is free from motion artefacts and that your film collection is displayed just as the Director intended!

For ease of installation, the projectors sport the supreme flexibility of five additional lens options, making it possible to project a perfect 4.7 meter image from only 1.3 meter from the screen, up to 7.8 meter image from 28 meters. The HT500 E-LINK and HT500 E also sport unparalleled features such as H/V electrical lens shift, digital keystone adjustment, absence of color wheel for an artifact-free image and many more.

HT500 E-LINK only: Remote DigiOptic™ Image Processor

The HT500 E-LINK features all the properties of the HT500 E plus SIM2's DigiOptic™ Image Processor, the remote unit equipped with a wide choice of inputs and linked to the projector through a thin digital fiber optic cable (0,14" diameter - 3,5mm).

The rack mount DigiOptic™ Image Processor can be installed next to the customer's equipment and up to 12 individual products can be connected at any one time.

This concept eases the problems with installation, no issues with interference or losses (quality connections up to 500 meters- 1600 ft) from long cable runs, electrical interference from telecommunications, power cables and lighting dimmers etc..

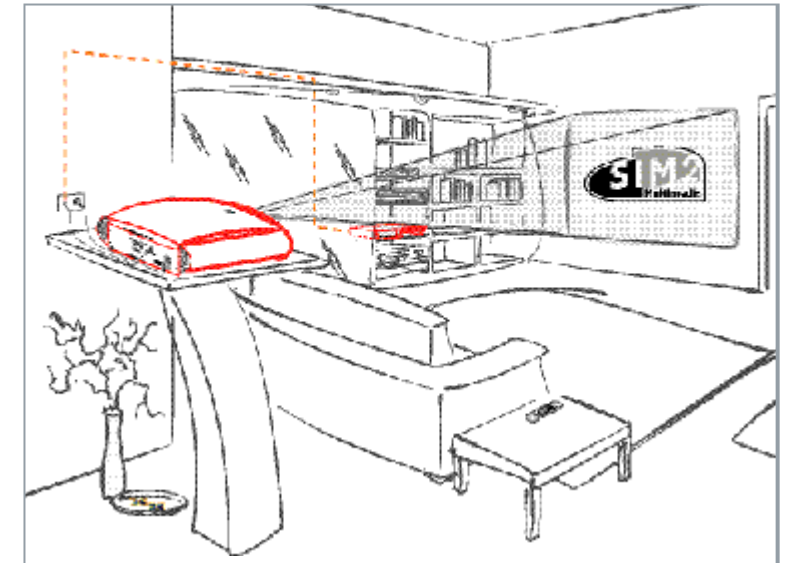

Design and colors

Italian Concept Designer Giorgio Revoldini has once again delivered a design that sports smooth curves, making the HT500 series a high-class focal point for any décor. The HT500 series is available in an elegant Dark Grey cabinet color.



Fiber Optics vs Copper: main advantages

- ✘ Speed: Fiber optic networks operate at high speeds - up into gigabits
- ✘ Bandwidth: Large carrying capacity
- ✘ Distance: Signals can be transmitted further without the need to be "refreshed" or strengthened
- ✘ Resistance: Greater resistance to electromagnetic noise such as radios, motors or other nearby cables
- ✘ Maintenance: Fiber optic cable has a lower maintenance costs

HT300 E-LINK and HT300 E

Your link to E-evolution

Key points

- ✦ The **first projectors** to feature **HD2+ DC3** chip (0.8" 720p DarkChip3™) by Texas Instruments
- ✦ True **contrast ratio: >3500:1**
- ✦ **1280 x 720 pixel (WXGA)** resolution
- ✦ **New Phono Absorbent Materials**
- ✦ **SIM2 Live Colors Management and Gamma adjustment**
- ✦ **HT300 E-LINK only: fiber optic connection**
- ✦ **HT300 E-LINK only: External DigiOptic™ Image processor** with 12 inputs (connection up to 500 m - 1600 ft via fiber optic cable)
- ✦ **Intelligent picture memory functions**
- ✦ **HDMI™ input**
- ✦ **Lamp life: 8000 hours**
- ✦ SIM2 proprietary alpha-path light engine
- ✦ On board Video Processing
- ✦ Lens shift and digital keystone adjustment
- ✦ Long Throw Ratio zoom lens

The E-evolution models - namely HT300 E-LINK and HT300 E - are the newest addition to the acclaimed and successful Grand Cinema HT series of home theater projectors.

New 0.8" 720p DarkChip3™ by Texas Instruments

The HT300 E-LINK and HT300 E projectors are the first on the market to feature the new 0.8" 720p DarkChip3™ by Texas Instruments (HD2+ DC3). A DMD chip contains an array of hinged microscopic mirrors that recreate a video or graphic source by reflecting or not reflecting light onto a projection surface, thereby producing a greyscale image. When a DMD mirror tilts away from its light source, a tiny space is opened into which stray photons can stumble. In first-generation DMD systems, these particles of light occasionally escaped to screen, subtly affecting the contrast ratio of the projected image.



In the DarkChip generation, a light-eating "dark metal" coat is applied to the interior of each chip, preventing stray light from traveling to screen when mirrors are switched off. Now, photons go only where they're wanted. The DarkChip3™ incorporates:

- **Reduced Via Size:** Utilizing a new hybrid mirror metal deposition technique the DarkChip3™, produces more uniform mirror thickness, superior metal deposition coverage within the via and from the center to the edge of the wafer
- **Reduced Pixel Gap**

Both of these features reduce the scattering of light, resulting in increasingly higher image contrast (+25%) and a further improved black color point / perception of black.

Also the DarkChip3™ is a Fast Track Pixel (FTP) chip that allows an approx. 50% reduction of the dithering effect for an exceptionally natural, crystal clear image.

Micro-mirror closeup

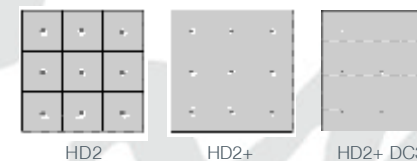

Contemporary cabinet design

The E-evolution projectors sport a new Phono-Absorbent cabinet to further reduce noise emissions resulting from the spinning of the color wheel, and it is available in three different colors: Gun Metal Grey (standard), Royal Burgundy, and Shiny Silver.



Phenomenal Contrast Ratio

The DarkChip3™ coupled with improved software and SIM2 high quality optics allow the HT300 E-LINK and HT300 E to reach a true contrast ratio of >3500:1 thus delivering on screen an image of unprecedented quality from a single chip projector

Intelligent Memory functions

The HT300 E-LINK and HT300 E can store up to 3 image memory settings such as brightness, contrast, color temperature, etc. for each input; that is 75 and 24 settings respectively. When you select a new source, the parameters stored in each memory may be applied simultaneously. Or, you may simply choose to recall despite the change of source.



Complete color control with SIM2 Live Colors Management (LCM) and Gamma functions

The HT300 E-LINK and HT300 E feature SIM2 LCM and Gamma functions. SIM2's new LCM algorithm allows you to precisely adjust color temperature to your preference. Simply choose a white point among the 36 predefined values inside the neutral color area of the CIE chromaticity diagram.

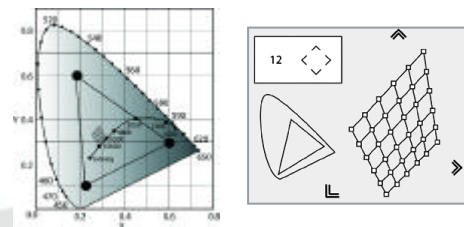

The horizontal lines set the low (right side, red component, 6.500°K) and high temperature values (left side, blue component, 10.000°K). The points along the lower horizontal line represent colors that belong to the black body curve.



Along the vertical lines the color temperature is constant but differs from the black body curve; for instance if you select a point from the higher part of the diagram you will increase the green component, while the lower part will increase the purple component. In addition, the Gamma Correction determines the system's response to the grey scale; The higher the gamma the faster the brightness decreases with signal intensity. SIM2's HT300 E-evolution projectors have 12 gamma curves available to optimize image based on variations in the source material, ambient lighting, and individual preferences: 5 STANDARD for movies, 5 ENHANCED to fully exploit the advantages of DLP technology, and 2 GRAPHICS for PC and graphic sources.



Future proof inputs and advanced video processing

The E-evolution projectors feature an impressive array of digital connections, including HDMI™. HDMI™ is a purely digital connection that transmits the uncompressed bitstream directly from the source through to the display - even high definition - and is backwards compatible with DVI. The on board Video Processing guarantees an image that is free from motion artefacts and that your film collection is displayed just as the Director intended!



DigiOptic™ Image Processor



Fiber optic cable



Fully-packed products

The HT300 E-LINK and HT300 E are all-inclusive projectors, featuring a sophisticated proprietary optical design for saturated and vibrant colors, high performance long lamp life for low operating costs, 6-segment color wheel for dramatically-reduced color separation artefacts, long throw ratio, power zoom and focus, and lens shift + Keystone Adj. to fine-tune the projectors from your viewing position.

The DigiOptic™ Image Processor (HT300 E-LINK only)

The HT300 E-LINK features all the properties of the HT300 E plus SIM2's DigiOptic™ Image Processor, the remote unit equipped with a wide choice of inputs and linked to the projector through a thin digital fiber optic cable (3,5mm - 0,14" diameter). This means incredible flexibility with the installation, greatly reducing the need for numerous long cable runs to the projector. The system is also upgradeable to accommodate future additional connections.

HT280 E

A simply stunning performance

key points

- ✦ Matterhorn DMD chip by Texas Instruments (1024x576 pixels resolution)
- ✦ True contrast ratio: >2500:1
- ✦ New Phono Absorbent Materials
- ✦ SIM2 Live Colors Management and Gamma adjustment
- ✦ Intelligent memory functions
- ✦ HDMI™ input
- ✦ SIM2 proprietary alpha-path light engine
- ✦ On board Video Processing
- ✦ Lens shift and digital keystone adjustment
- ✦ Long Throw Ratio zoom lens
- ✦ New, silent 6-segment color wheel
- ✦ Lamp life: 8000 hours

The HT280 E is a single chip DLP™ technology-based front projector featuring the 1024 x 576 Matterhorn chipset from Texas Instruments, ideally suited to European DVD and broadcast formats.

A newly enhanced SIM2 light engine, as featured in other Grand Cinema projectors, provides a true contrast ratio of around >2500:1 and delivers stunning film like image quality. The HT280 E long throw lens is perfect for positioning the projector at the back of the room, behind the audience to recreate a true cinematic experience.

A combination of SIM2 6 segment color wheel, Texas Instruments ED2 chip set and SIM2's new proprietary light engine, all components of the



HT280 E, ensures that the HT280 E delivers very accurate color rendition capabilities with vibrant reds, greens and blues for a film-like image.

Accurate color reproduction

Like all other Grand Cinema HT models, the HT280 E features SIM2 LCM and Gamma functions. The LCM algorithm allows you to precisely adjust color temperature to your preferences. Simply, choose from the 36 predefined white points in CIE Chart. In addition, you may choose from the wide range of possibilities provided by the Gamma Tables to optimize image to the connected source (12).

The HDMI™ input

The HT280 E sports the HDMI™ input. HDMI™ (High Definition Multimedia Interface) is an uncompressed digital connection that transmits HDTV at 2.2Gbps - with a strong content protection (HDCP) - directly from the source through to the display.



The HT280 E features a new Formatter Board that is integrated with the latest Video Processor. This new implementation to the hardware and software allows a broad series of functions such as video noise reduction, flesh tone correction, customized Adjustment of all parameters (different adjustments per input), overscan of 33 different positions, and auto Power On selectable.

The colors

The HT280 E is presented in the attractive world-renowned Grand Cinema HT cabinet design by Giorgio Revoldini and is available in SIM2's Gun Metal Grey color.





Crystal Clear
199

Grand Cinema RTX



The Grand Cinema RTX line was developed to challenge the concept of Home Theater Display. Innovative and unique both in technology solutions and aesthetic design, the RTX

epitomizes the mission of SIM2: delivering superior quality Home Theater display systems to Home Cinema enthusiasts.

Innovation, is the word often used when an unique product is developed. However, the expectations of the SIM2 customer are more than innovation, expecting products that do not become outdated both technically and on aesthetics. In addition to this, they expect performance as well as uniqueness and longevity.



The SIM2 RTX line offers an impressive alternative to other medium sized Home theater screens currently on the market, providing exceptional video performance from the DLP™ based light engine, through to a contemporary and stylish finish, befitting to the most diverse of home interiors.

Furthermore, the versatility of the SIM2 LINK concept allows for an incredibly discrete installation every time!

SIM2 has an impressive history in DLP™ front projection and as one of the pioneering manufacturers within this market has built a loyal customer base within their front projection range of products.

The SIM2 rear projection displays are however astounding the discerning front projector enthusiasts, who are amazed at the rich colors and sharp detail achievable from a SIM2 rear projection unit. With the Grand Cinema RTX, emotions and enthusiasm are enjoyed in the comfort of the most suitable environment: your own home.

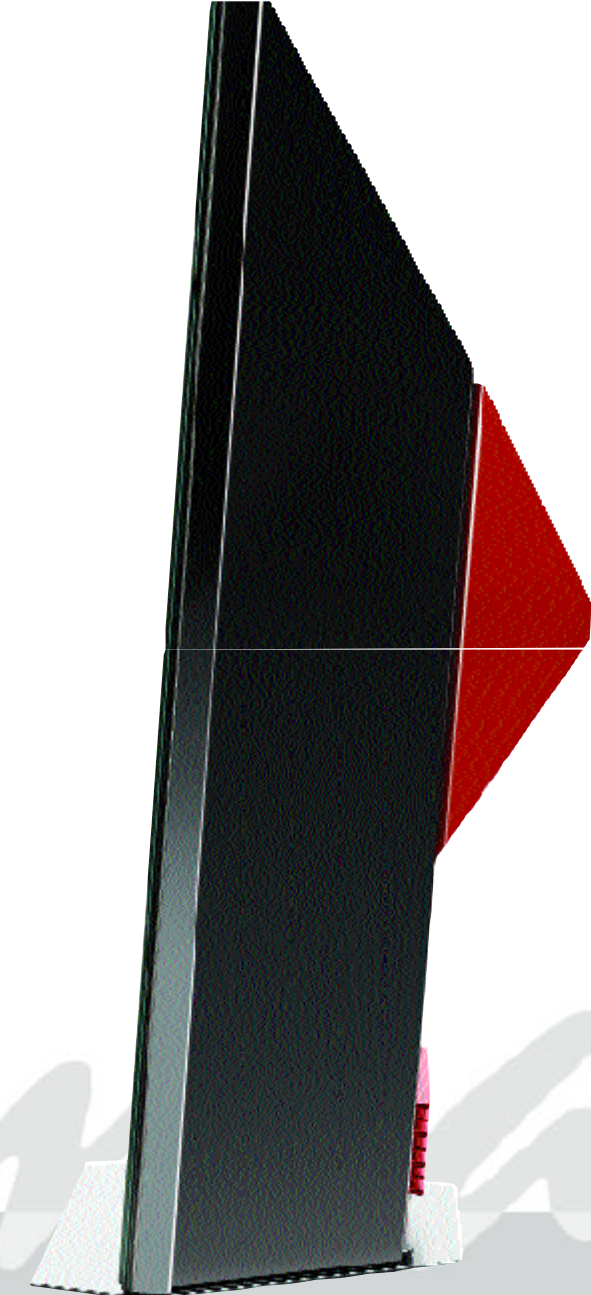

RTX55H

Make the most of your leisure time

key points

- ✗ **HD2+ DarkChip™** by Texas Instruments
- ✗ **1280 x720 pixel** resolution
- ✗ **55" screen dimensions**
- ✗ **Contrast ratio >2300:1**
- ✗ External **DigiOptic™ Image Processor** with 12 inputs (connection **via fiber optic cable**)
- ✗ Proprietary Fresnel lens and cabinet design
- ✗ Future-proof digital inputs: **HDMI™-HDCP and DVI**
- ✗ On board Video Processing
- ✗ Reduced depth
- ✗ **Lamp life: 6000 hours** under optimal conditions

After the success of Grand Cinema HT series, SIM2 realized the need to apply the projectors technology to a display device that could be utilized in a variety of rooms while fulfilling the need of the Home Theater enthusiasts.

The market is demanding a self contained product which features innovative exterior design and installation flexibility while maintaining the stunning picture the Grand Cinema HT projectors produce.

With this concept in mind, SIM2 designed the Grand Cinema RTX line: a revolutionary concept where image quality, technology and design are combined.



Video Entertainment: a new concept

Within the cabinet of the RTX, lies the heart of the system. Based on Texas Instruments DLP™ technology (HD2+ DarkChip), the Grand Cinema RTX55H delivers sharp, high contrast (>2300:1) images, edge-to-edge definition, an excellent colorimetry and grey scale tracking.

The Grand Cinema RTX55H is available in 55" diagonal screen size - 16:9 image format) and far exceeds today's standards of technology. Features such as a fiber optic link, high speed laser, custom-made lens and engine, latest generation video processing and finally HDMI™ input, all create a truly future proof product.

In fact, the RTX 55H integrates perfectly within your existing high-end audio system. All inputs can be conveniently connected via the SIM2 proprietary DigiOptic™ Image Processor, a remote system that channels the input feeds, including the newly added HDMI™ digital connector and DVI, along a thin kevlar-coated fiber optic cable to the RTX



system. This, together with the RTX55H simple menus and vertical tilting system, make installation and set-up easy and fast.

SIM2 manufactures all of their products with foresight and the RTX line is no exception. It can be constantly upgraded via the RS232 connector and is fully compatible with emerging products and technologies.

Also, the RTX line features three custom-made components (SIM2 patent rights): first, a high resolution projection lens for reduced cabinet depth; second, a specific Fresnel lens to match the DMD chip; and, third, an improved and sealed light engine for super-high contrast (>2300:1) and black level.



Through your eyes and emotion you will be left breathless every time you watch your Grand Cinema RTX

The RTX55H features the well received SIM2's DigiOptic™ Image Processor, the remote processor box equipped with a wide choice of inputs and linked to the projector through a thin fiber optic cable (3,5mm - 0,14" diameter).

With this innovative feature of using an external input/image processing box connected via fiber optics to the projector, SIM2 has made installation and signal management an easy task.

Video sources are typically located far away from the projector and it is becoming very difficult to run HD-compatible cables for long distances. With the DigiOptic™ Image Processor this issue no longer exists.



Based on a Complementary Metal Oxide Semiconductor (CMOS) chip-set the optical link allows a fully digital source-to-display link, which is capable of transmitting data over a distance in excess of 1600 ft, with 3 high-speed lasers between the DigiOptic™ Image Processor and the projector for a loss-free and interference-free signal..

The Grand Cinema RTX55H elegant cabinet (available in different colors) is immediately recognizable: A fancy crystal front, a reduced depth of 14,5" (approx. 37 cm), sophisticated shapes, and prestigious material make it a true masterpiece by the award winning designer - Giorgio Revoldini.

BS_BlackShadow

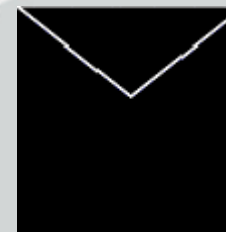

SR_SilverRed



BR_BlackRed

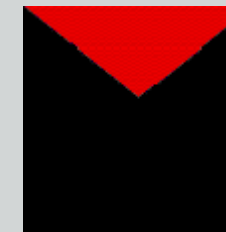

SG_SilverGrey

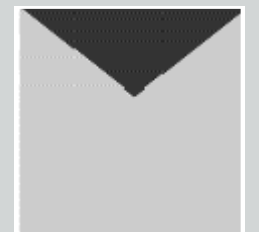



HTL40 LINK and HTL40

Challenging the way you perceive images

key points

- ✗ 40" (101cm), 16:9 Aspect Ratio
- ✗ Advanced TFT LCD panel
- ✗ WXGA resolution: 3,147,264 pixels
- ✗ 170° Viewing Angle
- ✗ High pixel response time
- ✗ True contrast ratio: 1000:1
- ✗ High brightness: >600 cd/m2
- ✗ HTL40 LINK only: The first LCD display to feature fiber optic connection
- ✗ HTL40 LINK only: External DigiOptic™ Image Processor with 12 inputs
- ✗ HDMI™-HDCP & DVI (HTL40LINK) inputs
- ✗ On board Video Processing
- ✗ Intelligent memory functions
- ✗ 60.000 hours lamp life time
- ✗ Wall Mount (standard)
- ✗ Crystal or Matt Silver tabletop support (optional)
- ✗ Elegant cabinet design available in 3 different colors

Unprecedented image quality

The 40-inch HTL40 series combines state-of-the-art technology and stylish, compact design and is available with (HTL40 LINK) or without (HTL40) SIM2's DigiOptic™ Image Processor. Featuring the latest TFT panel technology, the HTL40 series has a WXGA resolution of 1366 x 768 - fitting a native 16:9 aspect ratio - and an enhanced 1000:1 contrast ratio. The HTL40 displays deliver rich, saturated colors, a superb grey scale tracking, and a brightness of 600 cd/m2, for a sharp vivid picture even in direct sunlight conditions.

Intelligent Memory functions

The HTL40 LINK and HTL40 can store up to 3 image memory settings such as brightness, contrast, color temperature, etc. for each input; for a total of 75 settings and 24 respectively. When you select a new source, the parameters stored in each memory may be applied simultaneously. Or, you may simply choose to recall it despite the change of source type.



Design and colors

The HTL40 series sports a contemporary and stylish design, befitting to the most diverse of home interiors; a new masterpiece by the award-winning designer Giorgio Revoldini. The adopted technological solutions represent the best in terms of material selections. Every component speaks of attention to details: from the front crystal glass, to the refined wood or matt silver back panels, to the crystal or Matt Silver tabletop support (optional).

The HTL40 series back panel is available in Matt Silver (standard) and two types of refined woods: Rosewood or Whitened Oak.

Also, LCD allows screens to be thinner than ever before. In fact, the HTL40 series, with its depth of only 10,2 cm (4") not only can fit flat on a wall, it can fit in places conventional televisions cannot.

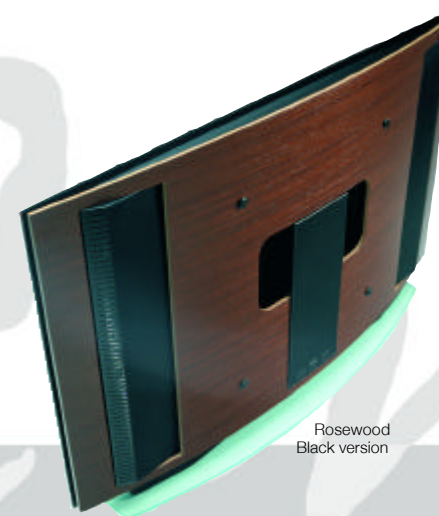

Rosewood
Black version

HTL40 LINK only: the DigiOptic™ Image Processor

The HTL40 LINK features SIM2's DigiOptic™ Image Processor, the remote unit equipped with a wide choice of inputs and linked to the display through a thin digital fiber optic cable (3,5mm - 0,14" diameter). This means incredible flexibility with the installation, greatly reducing the need for numerous long cable runs to the display. The system is also upgradeable to accommodate future additional connections.

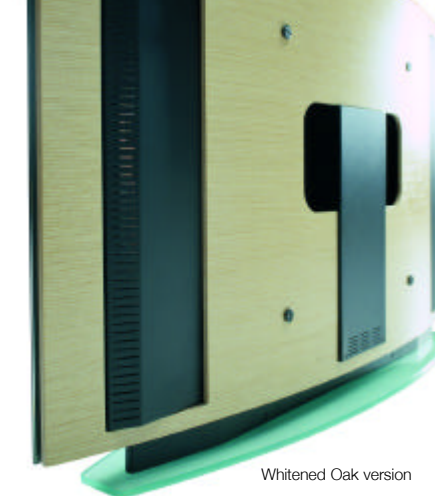

Whitened Oak version

Extraordinary Features

The HTL40 LINK and HTL40 displays feature an impressive array of digital connections, including HDMI™ and DVI. HDMI™ is a purely digital connection that transmits the uncompressed bitstream directly from the source through to the display - even high definition - and is backwards compatible with DVI. The on-board Video Processing guarantees an image that is free from motion artefacts and that your film collection is displayed just as the Director intended!

Wide Viewing Angle and long-life lamp

You can enjoy watching the HTL40 LINK and HTL40 from a variety of angles and distances up to 170 degrees horizontally and vertically. Also, the HTL40 series is equipped with a high performance, long-life lamp (60.000 hours) for low operating costs.



Technical Specifications

GRAND CINEMA HT

HT500 E-LINK



HT500 E



HT300 E-LINK



HT300 E



HT280 E

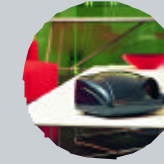

LIGHT ENGINE

DLP™ Type	3 Chip DMD™ HD2+	3-Chip DMD™ HD2+	1 DMD HD2+ DarkChip3™	1 DMD HD2+ DarkChip3™	1 Chip DMD™ ED2
Resolution	1280x720	1280x720	1280x720	1280x720	1024x576
Lens	High Quality, high resolution improved optics for higher contrast and better black level with both motorized zoom and focus adj.	High Quality, high resolution improved optics for higher contrast and better black level with both motorized zoom and focus adj.	High Quality, high resolution improved optics for higher contrast and better black level with both motorized zoom and focus adj.	High Quality, high resolution improved optics for higher contrast and better black level with both motorized zoom and focus adj.	High Quality, high resolution improved optics for higher contrast and better black level with both motorized zoom and focus adj.
Lamp power consumption & life time*	250W, 1500 hours	250W, 1500 hours	120W 8000 hours	120W 8000 hours	120W 8000 hours

INSTALLATION

Throw ratio	1,44-1,8:1 (standard lens - type L2)	1,44-1,8:1 (standard lens - type L2)	1,8-2,4:1	1,8-2,4:1	2,1-3,1:1
Lens shift	V+13°-5,5° ; H +/--3,9°;	V+13°-5,5° ; H +/--3,9°;	V+/--8°	V+/--8°	V+/--10°
Digital keystone adjustment:	V+/--18°; H+/--10°	V+/--18°; H+/--10°	V+/--18°; H+/--10°	V+/--18°; H+/--10°	V+/--18°; H+/--10°
Picture size (inches diagonal)	50-300	50-300	50-250	50-250	50-250
Aspect ratio: 4:3, 16:9 Anamorphic, LetterBox, panoramic, pixel to pixel + 3 custom-user adjustments	•	•	•	•	•

ELECTRONICS

Horizontal & vertical scan freq.: 15-80kHz/48-100Hz	•	•	•	•	•
SDTV: PAL (B,G,H,I,M,N,60); SECAM; NTSC 3,58; NTSC 4,43 automatically selected	•	•	•	•	•
HDTV: ATSC (480p, 720p, 1080i, 1080p); 576p	• + 1080i 50Hz	• + 1080i 50Hz	• + 1080i 50Hz	• + 1080i 50Hz	•
PC graphic standard: VGA, SVGA, XGA, SXGA, UXGA @ 60 Hz.	• UXGA @ 65Hz	• UXGA @ 65Hz	•	•	•
On Board Video Processing	•	•	•	•	•
Contrast ratio (Full ON/ Full OFF)	>4300:1	>4300:1	>3500:1	>3500:1	>2500:1
Color temperature: 3 preset color temperatures + RC user adjustment acting directly on each color (RGB)	•	•	•	•	•
Special video adjustments: noise reduction, fleshtone regulation	•	•	•	•	•
Other special adjustments: memories/overscan	•	•	•	•	•

INPUTS/OUTPUTS

	On DigiOptic™ Image Processor		On DigiOptic™ Image Processor		
Composite Video (RCA)	2	1	2	1	1
S-Video (mini Din 4 pin)	2	1	2	1	1
RGBS/YCrCb (RCA)	-	-	-	1	1
RGBHV/YCrCb (RCA)	3	1	3	-	-
RGBHV/YCrCb (BNC)	1	1	1	-	-
RGBHV (D-Sub 15 pin)	2	1	2	1	1
DVI (DVI-D)	1	1	1	-	-
HDMI™	1	1	1	1	1
OUT Digital Audio (Toslink)	1	1	1	1	1
RS232 (D-Sub 9 pin)	1	1	1	1	1
OUT 12V 100mA (via Jack)	2	2	2	2	2

* Choice of 5 different lenses with these throw ratio: 0,64:1 1,2-1,44:1 1,8-2,4:1 2,4-3,6:1 3,6-5,6:1

(*) Lamp life: the hours quoted have been calculated under strict test conditions. Misuse or improper use may later it.

GRAND CINEMA HT

HT500 E-LINK



HT500 E



HT300 E-LINK

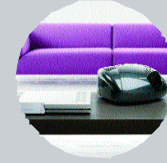

HT300 E



HT280 E

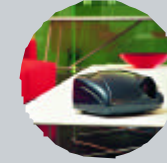

GENERAL SPECIFICATIONS

Software control: upgradable via RS232 serial interface	•	•	•	•	•
Power consumption:	340W max	340W max	180W max	180W max	180W max
Mains voltage range: 120-240Vac ±10% (48/62Hz)	•	•	•	•	•
Weight:	61.7 lbs (28Kg.)	61.7 lbs (28Kg.)	12.8 lbs (5.8 Kg.)	12.8 lbs (5.8 Kg.)	12.8 lbs (5.8 Kg.)
Dimensions (WxHxD):	21.25"x8.27"x24.21" (540x210x615mm)	540x210x615mm (21.25"x8.27"x24.21")	13.8"x6.8"x12.5" (350x173x318mm)	13.8"x6.8"x12.5" (350x173x318mm)	13.8"x6.8"x12.5" (350x173x318mm)

SUPPLIED ACCESSORIES

Installation and User Manual	•	•	•	•	•
AC power cords 6,6 ft (2m) (EU, UK ed USA)	•	•	•	•	•
Remote control and batteries	-	-	-	-	-
Backlit remote control and batteries	•	•	•	•	•
DigiOptic™ Image Processor	•	-	•	-	-
Fiber optics cable - 65,6 ft (20 m)	•	-	•	-	-
HDMI™ cable - 6,6 ft (2m)	•	-	-	-	-
DVI – HDMI™ cable - 6,6 ft (2m)	•	-	-	-	-

OPTIONAL ACCESSORIES

HT BRKT floor and ceiling mounting bracket	• (ceiling mounting only)	•	•	•	•
HT fiber optics cable 131,2 ft (40m)	•	-	•	-	-



GRAND CINEMA RTX

RTX55-H



LIGHT ENGINE

DLP™ Type	1 Chip DMD HD2+ DarkChip2
Resolution	1280x720
Lens	High quality, high resolution optics
Lamp power consumption & life time*	120W 6000 hours

INSTALLATION

Picture size (inches diagonal):	55
Aspect ratio: 4:3, 16:9 Anamorphic, LetterBox, 3 custom-user adjustments + panoramic and pixel to pixel	•

ELECTRONICS

Horizontal & Vertical scan freq.: 15-80kHz/48-100Hz (freq. Max H = UXGA 60Hz)	•
SDTV: PAL (B,G,H,I,M,N,60); SECAM; NTSC 3,58; NTSC 4,43 automatically selected	•
ATSC (480p, 720p, 1080i, 1080p); 576p	• + 1080i 50Hz
PC graphic standards: VGA, SVGA, XGA, UXGA (1600x1200)	•
On Board Video Processing	•
Contrast ratio (Full ON/ Full OFF)	>2300:1
Color temperature: 3 preset color temperatures + a RC user adjustment acting directly on each color (RG)	• + high and low light
Special adjustments: noise reduction, fleshtone regulation, memories/overscan	•

INPUTS / OUTPUTS

	on DigiOptic™ Image Processor
Composite Video (RCA)	2
S-Video (mini Din 4 pin)	2
RGBHV/YCrCb (RCA)	3
RGBHV/YCrCb (BNC)	1
RGBHV (D-Sub 15 pin)	2
DVI (DVI-D)	1
HDMI™	1
OUT Digital Audio (Toslink)	1
RS232 (D-Sub 9 pin)	1
OUT 12V 100mA (via Jack)	2

GENERAL SPECIFICATIONS

Control: control software upgradable via RS232 serial interface	•
Power consumption	170W max
Mains voltage range: 100-240Vac ±10% (48/62Hz)	•
Weight:	187,4 lbs (85 Kg)
Dimensions (WxHxD)	58.82"x48.35"x16.73" (1495x1218x421mm)

SUPPLIED ACCESSORIES

Installation and User Manual; AC power cords 6,6 ft (2m) (EU, UK ed USA); Backlit remote control and batteries	•
DigiOptic™ Image Processor; Fiber optics cable- 65,6 ft (20 m); HDMI™ cable 6,6 ft (2m)	•

OPTIONAL ACCESSORIES

HT fiber optics cable 40m	•
---------------------------	---

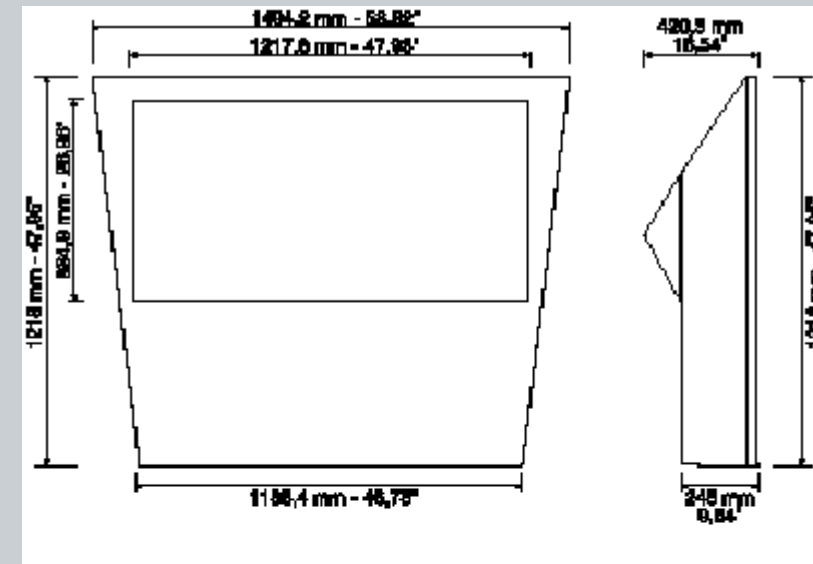

(*) Lamp life: the hours quoted have been calculated under strict test conditions. Misuse or improper use may later it.

GRAND CINEMA HTL

HTL40 LINK



HTL40



DISPLAY

LCD PANEL:	latest generation TFT LCD	latest generation TFT LCD
Resolution: Wide XGA (1366x768 x3) 3.147.264 pixels for HD Images	•	•
Picture Format - Screen Size: true 16:9, 40"	•	•
Brightness: 600 cd/m ²	•	•
Contrast ratio: 1000:1	•	•
Viewing Angle: 170°	•	•
Lamp life time*: 60.000 hrs in standard lighting conditions and brightness	•	•
Response Time: Typical 8ms	•	•

ELECTRONICS

Horiz. scan freq.: 15-80KHz - Vert. Scan freq.: 48 - 85Hz	•	•
Aspect ratio:	16:9 Anamorphic, LetterBox, panoramic, pixel to pixel + 3 custom-user adjustments	
Video Signals Compatibility:	PAL (B, G, H, I, M, N, 60); SECAM; NTSC 3,58; NTSC 4,43 automatically selected	
HDTV:	ATSC (480p, 720p, 1080i, 1080p); 576p + 1080i 50Hz;	
PC graphic standard:	VGA, SVGA, XGA, SXGA, UXGA (1600X1200 60 Hz)	
On Board Video Processing	•	•
Color Temperature: 3 preset color temperature selectable by OSD	•	•
Special adjustments: noise reduction, flesh tone regulation, overscan,	•	•
Intelligent picture memory functions: 75 total - 3 for each input	•	•

INPUTS/OUTPUTS

(on DigiOptic™ Image Processor)

Composite Video (RCA)	2	1
S-Video (mini Din 4 pin)	2	1
RGBS/YCrCb (RCA)	-	2
RGBHV/YCrCb (RCA)	3	-
RGBHV/YCrCb (BNC)	1	-
RGBHV (D-Sub 15 pin)	2	1
DVI (DVI-D)	1	-
HDMI™ - HDCP	1	1
OUT Digital Audio (Toslink)	1	1
RS232 (D-Sub 9 pin)	1	1
OUT 12V 100 mA (via jack)	2	-
USB	-	1

GENERAL SPECIFICATIONS

Power Consumption: 200 W	•	•
Mains Voltage Range: 90 - 240V AC	•	•
Weight: 35 Kg net (77 lbs)	•	•
Dimensions (WxHxD) without tabletop support (stand)	43.54"x25.67"x4"	43.54"x25.67"x4"
	1106x652x102 mm	1106x652x102 mm
Dimensions (WxHxD) with tabletop support (stand)	43.54"x27.63"x9.05"	43.54"x27.63"x9.05"
	1106x702x230 mm	1106x702x230 mm

(*) Lamp life: the hours quoted have been calculated under strict test conditions. Misuse or improper use may alter it.

GRAND CINEMA HTL

HTL40 LINK



HTL40



SUPPLIED ACCESSORIES

Installation and User Manual	•	•
AC Power cords (EU,UK,and USA) 6.6 ft (2m)	•	•
Backlit remote control and batteries	•	•
DigiOptic™ Image Processor	•	-
Fiber optics cable - 65,6 ft (20 m)	•	-
HDMI cables - 6,6 ft (2m)	•	-
DVI - HDMI™ cables 6,6 ft (2m)	•	-

OPTIONAL ACCESSORIES

Crystal desktop support	•	•
Aluminium desktop support	•	•
HT fiber optics cable 131,2 ft (40 m)	•	-

CABINET COLORS AND MATERIALS

Matt Silver Rear Panel and stand in Aluminium	•	•
Black Rosewood: Rosewood rear panel and Crystal stand	•	-
Whitened Oak: Whitened Oak rear panel and Crystal stand	•	-

