

EPSON[®]
EXCEED YOUR VISION



PowerLite[®] 93+ MULTIMEDIA PROJECTOR



Brilliant image quality and network control.

The network-controllable PowerLite 93+ upgrades the classroom experience with HDMI digital connectivity and powerful performance. Monitor and control the projector over your network using the RJ-45 connector, saving you time and money. XGA resolution and 2600 lumens of color and white light output¹ ensure bright, clear images, while the premium 16 W speaker delivers powerful audio, without added cost. A built-in closed captioning decoder accommodates students with hearing impairments. And, the E-TORL[®] lamp stretches your equipment dollar with an impressive lamp life up to 6000 hours². Easy to manage and control over the network, the PowerLite 93+ brings brighter, more engaging presentations to more classrooms.

Bright, brilliant presentations — 2600 lumens color light output¹, 2600 lumens white light output¹ and XGA (1024 x 768) resolution

Powerful, 16 W speaker — no external speakers required; saves on equipment costs

Future-ready connectivity — HDMI input for digital connectivity with the latest laptops and media players; delivers high-quality audio and video with just one cable

Advanced network control — RJ-45 connectivity for remote projector management



The best-selling projectors in the world.

Epson understands education and has a solution no matter what your teaching scenario. Built with image quality and reliability in mind, EPSON projectors enhance communication and inspire collaboration, while offering a low total cost of ownership. From long-throw projectors designed for traditional educational settings to ultra-short-throw and all-in-one solutions built for progressive classrooms, Epson has the model made for you.



3LCD technology — for quality and color that's beyond amazing

Innovative technology with proven reliability

- 3 chips for full-time, vibrant color
- 25% less electricity required per lumen of brightness when compared to 1-chip DLP projectors³
- Over 20 years of road-tested reliability built into every projector

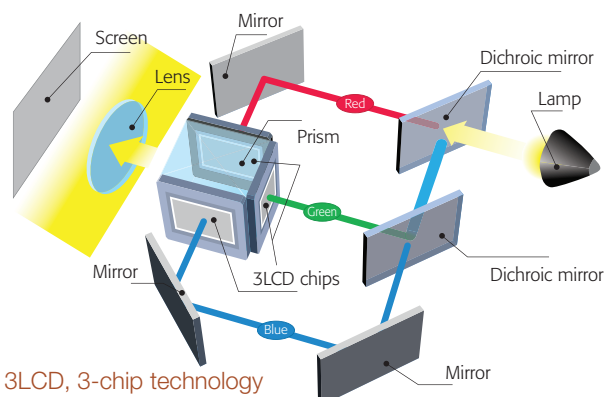

Amazing light output

- 2600 lumens color light output and 2600 lumens white light output¹
- High color light output for bright, balanced, colorful images
- White light output that's measured using ISO 21118 (a more rigid standard than the outdated ANSI lumens rating used by some competitive products)

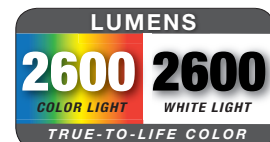

High color light output



Low color light output

Actual photographs of images taken from two competing projectors run in default mode. Price, resolution and brightness (white light output) are the same for both projectors.

High-quality images with HDMI digital connectivity

- Delivers both audio and brilliant video content with just one cable
- Compatible with the latest laptops, Blu-ray® and media players



Built-in closed captioning

- Essential for education — helps meet ADA508 requirements for students with hearing impairments
- Helps save money — no need to pay for an additional decoder and its installation
- Effective and easy to use — easily enabled through the projector remote or menu



Energy-efficient E-TORL lamp, exclusively from EPSON

- Long lamp life lasts up to 6000 hours²
- Minimizes both light diffraction and light leakage
- E-TORL lamps maximize your presentation time, while minimizing your costs

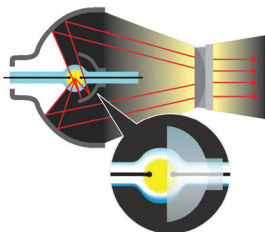

E-TORL lamp

Better Products for a Better Future™

For more information on Epson's environmental programs, go to eco.epson.com

Eco Features

- Energy-efficient 3LCD light engine
- Low power consumption of 0.3 W in Standby Mode (communication off)
- Energy-efficient E-TORL lamp
- Recyclable product⁴
- Epson America, Inc. is a SmartWaySM Transport Partner⁵





RJ-45 network connectivity

- Easily monitor/control networked EPSON projectors remotely, using the RJ-45 connector and EasyMP® Monitor software
 - Save time and maintenance costs — power classroom projectors on and off without having to go to each individual classroom; set schedules for automatic events
 - Receive e-mail alerts when attention is required
 - Crestron RoomView™ enabled — monitor/control your projector with RoomView software, without the need for an A/V control box



Advanced 3-in-1 USB Plug 'n Play instant setup — for PC and Mac®

- Three features, all with one standard USB connection — display your presentation, transmit audio and control your presentation



Fast, easy setup and control

- 1.2x optical zoom gives you the flexibility to adjust your presentation to suit your space and audience, without sacrificing image quality
- Direct Power On/Off — power the projector on and off with the flip of a light switch
- Instant Off® — no cool-down time required, so it's ready to shut down when you are
- A/V Mute — control your presentation using the remote or by closing the slide; it's right at your fingertips
- Sleep Mode — set from 1 to 30 minutes to save energy and lamp life when the A/V Mute Slide is closed or no signal is detected

Horizontal keystone correction

- +/-30 degrees provides the ultimate projector placement flexibility
- Allows for off-center positioning of the projector, and still ensures a correctly proportioned image

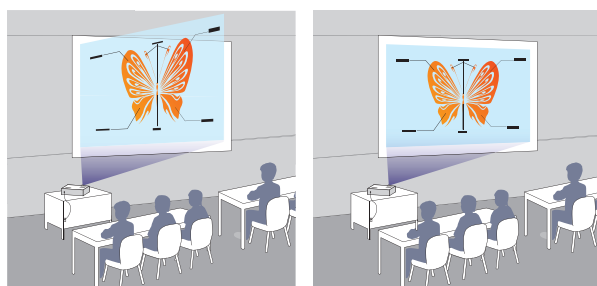

Without horizontal keystone

With horizontal keystone

Quick Corner®

- This innovative feature allows you to move any of the four corners of an image independently, to adjust each corner for a perfectly rectangular picture



Before

After

PowerLite 93+

Additional Features

- **Versatile connectivity for the classroom** — HDMI, USB, audio out, monitor out, computer/VGA inputs, LAN and RS-232c
- **Easy maintenance** — easy lamp and air filter access for quick, convenient replacements
- **Added security in any environment** — convenient metal anchor bar and Kensington® lock support
- **New high-density filter** — twice the surface area of our previous generation adds a higher level of protection

Expanded USB functionality

- Partner your projector directly with the EPSON DC-06 document camera
- Deliver PC-free slideshows using a USB flashdrive (supports multiple file formats — JPEG, PNG, GIF and BMP)

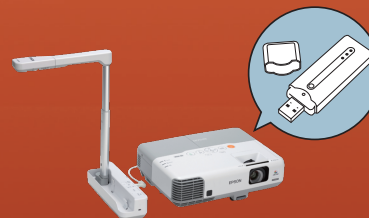

Built-in teaching aids save time

- Choose from four pre-set templates or create a custom template to project lines or grids onto whiteboards or chalkboards
- Simply display the pattern by using the customizable User button on the projector remote control

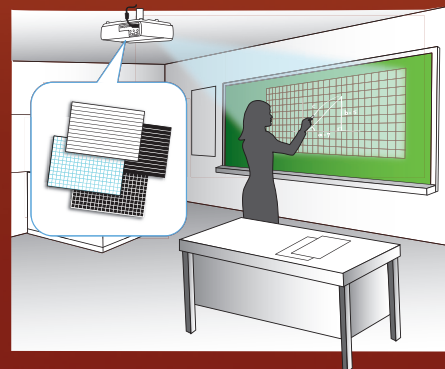

Easily project lines or grids with built-in templates

Filters to protect your investment

Because we know how important it is to protect your valuable investment, Epson has designed this 3LCD projector with a higher density filter to give you added peace of mind. A filter helps limit the amount of dust that can settle on the internal components and reduce the lamp life or dull the image. When the time comes to clean or change the filter, just open the filter door, vacuum the dust off or replace the filter, close the door, and you're done!

PowerLite® 93+

Multimedia Projector

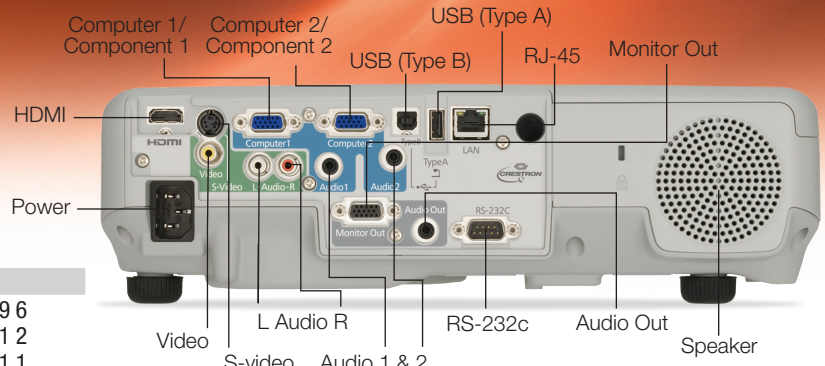

Product Name	Product Code	UPC
PowerLite 93+ projector	V11H382120	0 10343 90019 6
Genuine EPSON lamp	V13H010L60	0 10343 88041 2
Replacement air filter	V13H134A29	0 10343 88051 1

Specifications

Projection System
EPSON 3LCD, 3-chip technology

Projection Method
Front/rear/ceiling mount

Driving Method
EPSON Poly-silicon TFT Active Matrix

Pixel Number
786,432 dots (1024 x 768) x 3

Color Light Output¹
2600 lumens

White Light Output¹
2600 lumens (ISO 21118 standard)

Aspect Ratio
4:3

Native Resolution
1024 x 768 (XGA)

Resize
640 x 480 (VGA), 800 x 600 (SVGA),
1152 x 864 (SXGA), 1280 x 800 (WXGA),
1280 x 960 (SXGA2), 1280 x 1024 (SXGA3),
1280 x 768 (WXGA 60-1), 1360 x 768
(WXGA 60-2), 1440 x 900 (WXGA+),
1400 x 1050 (SXGA+), 1600 x 1200 (UXGA)

Lamp Type
200 W UHE (E-TORL)

Lamp Life²
Up to 6000 hours (ECO Mode)
Up to 5000 hours (Normal Mode)

Throw Ratio Range
1.48 – 1.77

Size (projected distance)
30" to 300" (0.9 to 9.0 m)

Keystone Correction Automatic
Vertical ± 30 degrees

Keystone Correction Manual
Horizontal ± 30 degrees

Mac Connectivity
Projector is Mac compatible via USB, DVI to
HDMI or VGA adapter (not included)

Contrast Ratio
Up to 2000:1

Color Reproduction
16.77 million colors

Projection Lens

Type
Manual optical zoom/Manual focus

F-number
1.58 – 1.72

Focal Length
16.9 mm – 20.28 mm

Zoom Ratio
Optical zoom 1.0 – 1.2

Other

Display Performance
NTSC: 480 lines
PAL: 576 lines
(Depends on observation of the multi-
burst pattern)

Input Signal
NTSC/NTSC4.43/PAL/M-PAL/N-PAL/
PAL60/SECAM

Interfaces
Computer/component video: D-sub 15 pin x 2
S-video: Mini DIN x 1
Composite video: RCA (Yellow) x 1
USB connector: Type B x 1 (USB display, audio
and mouse control)
USB connector: Type A x 1 (USB memory/
document camera)
HDMI x 1
RJ-45 x 1
Audio in: RCA x 1 (L and R), Mini stereo x 2
Monitor out: D-sub 15 pin x 1
Audio out: Mini stereo x 1
Serial: RS-232c x 1

Speaker
16 W (mono)

Operating Temperature
41 ° to 95 °F (5 ° to 35 °C)

Power Supply Voltage
100 – 240 V ± 10%, 50/60 Hz

Power Consumption
312 W
0.3 W Standby (communication off)

Fan Noise
33 dB (Normal Mode)
28 dB (ECO Mode)

Security
Kensington-style lock provision
Padlock and security cable hole
Password protect function

Dimensions (W x D x H)

Including feet: 13.6" x 10.3" x 4.2"
Excluding feet: 13.6" x 10.3" x 3.7"
Weight: 6.9 lb

Remote Control

Features
Source search, video, LAN, USB, computer,
power, aspect, color mode, volume, e-zoom,
A/V mute, freeze, menu, page up and down,
help, auto, mouse functions, user, esc

Operating Angle
Right/left: ± 30 degrees
Upper/lower: ± 30 degrees

Operating Distance
19' (6 m)

Support

The EPSON ConnectionSM
Pre-sales support
U.S. and Canada 800-463-7766
Internet website www.epson.com

Service Programs
Two-year projector limited warranty, EPSON Road
Service program, PrivateLine® dedicated toll-
free support and 90-day limited lamp warranty

What's In The Box
PowerLite 93+ projector, power cord,
computer cable (VGA), projector remote control,
batteries, user manual CD, projector software
CD, Quick Setup Sheet, PrivateLine support
card and password protection sticker

Accessory Part Numbers

Genuine EPSON lamp	V13H010L60
Replacement air filter	V13H134A29
EPSON DC-06 document camera (ELPDC06)	V12H321005
EPSON DC-11s document camera (ELPDC11)	V12H377020
AP-60 projector sound solution	V12H329020
Universal projector ceiling mount	ELPMBPJF
Adjustable suspended ceiling channel kit	ELPMBP01
False ceiling plate kit	ELPMBP02
Structural round ceiling plate	ELPMBP03
Adjustable extension column (pipe) 8"-11"	ELPMB0C1
Component to VGA cable	ELPKC19
Kensington security lock	ELPSL01
Soft carrying case (ELPKS64)	V12H001K64
Duet™ screen	ELPSC80
ES3000 portable screen (ELPSC26H)	V12H002S3Y
BrightLink Solo™ interactive module (IU-01)	V12H415020
BrightLink Solo interactive module with RM	V12H415020RM
Easiteach (IU-01)	1519442
Replacement remote control	ELPSP10
PixiePlus™ control system	ELPSP10
ELPSP02 speakers	V12H467020

Packaging Specifications

PowerLite 93+
Dimensions: 19.1" x 14.1" x 6.7" (W x D x H)
Weight: 10.8 lb

Genuine EPSON Lamp
Dimensions: 6.3" x 5.6" x 5.6" (W x D x H)
Weight: 0.7 lb
Master Carton
Dimensions: 28.4" x 13.1" x 6.8" (W x D x H)
Weight: 9.5 lb
Units Per Master Carton: 10

Replacement Air Filter
Dimensions: 4.9" x 3.9" x 1.2" (W x D x H)
Weight: 0.1 lb
Master Carton
Dimensions: 12.7" x 5.2" x 4.6" (W x D x H)
Weight: 1.1 lb
Units Per Master Carton: 10

1 Color and white light output will vary depending on mode selected. White light output measured using ISO 21118 standard.
2 Lamp life will vary depending upon mode selected, environmental conditions and usage. Lamp brightness decreases over time.
3 Data source: ProjectorCentral.com, Jan. 2011. Average of 1038 shipping models for which manufacturers provided lumens and total power data, all resolutions and brightness levels.
4 See our website for convenient and reasonable recycling options at www.epson.com/recycle
5 SmartWay is an innovative partnership of the U.S. Environmental Protection Agency that reduces greenhouse gases and other air pollutants and improves fuel efficiency.

EPSON America, Inc.
3840 Kilroy Airport Way, Long Beach, CA 90806

EPSON Canada Limited
185 Renfrew Drive, Markham, Ontario L3R 6G3

www.epson.com
www.epson.ca